

## Model 522 SLR

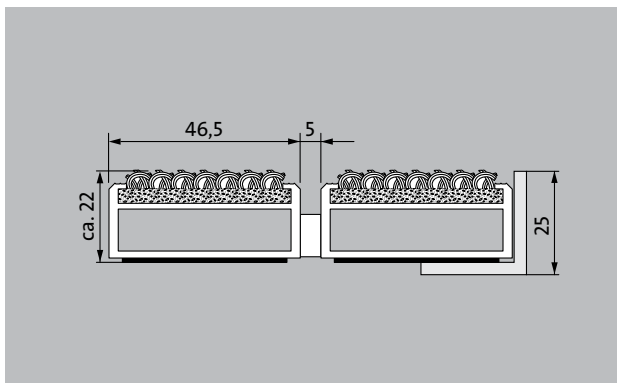

The extra-wide original entrance mat with the effective, coarse-fibre rib insert is exceptionally abrasion resistant and offers maximum dimensional stability. Particularly ideal for collecting fine dirt. Optimally designed for buildings exposed to extreme footfall.

**1** **2** **3** Indoor and outdoor (covered, Zone 1+2)

### Description

Rollable, extremely hard-wearing, original entrance mat with extra-wide profile bars and standard insert for supported and self-supporting installation options. Also capable of withstanding wheeled traffic. Customisable widths and walking depths available without a compensation profile. Available in any geometric shape.



Indoor and outdoor (covered, Zone 1+2)



Street dust, hair, sand, ash, textile fibres, small leaves and twigs, etc.



R11 slip resistance as per DIN 51130



4 year warranty

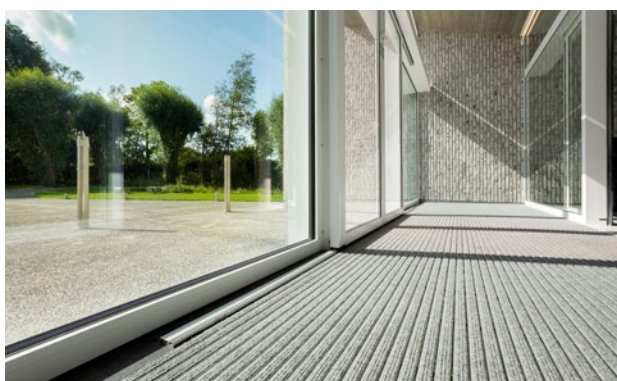

# emco MARSCHALL Original Large With ribbed carpet insert

## Model 522 SLR

<b>Approx. height (mm)</b>	22
<b>Roll-over and drive-over capability:</b>	<p>Prams</p> <p>Sack-/hand truck</p> <p>Wheelchairs</p> <p>Light shopping trolleys</p> <p>hand trolleys</p> <p>pallet trucks</p> <p>Electric lift truck</p> <p>Cars</p>
<b>Standard profile clearance approx. (mm)</b>	5 mm, rubber spacers
<b>Automatic door systems</b>	Profile clearance of 3 mm available as an option for revolving door drives, in accordance with EN 16005
<b>Connection</b>	Plastic-coated stainless steel cable
<b>Max. width/profile length for individual section (mm):</b>	3000
<b>Profile width (mm)</b>	46.5
<b>Depth/walking depth for individual section (mm):</b>	800
<b>Weight (kg/m<sup>2</sup>)</b>	13,2
<b>Mat division as per factory standards</b>	From a profile length of 3000 mm or a maximum mat weight of 30 kg. For profile lengths above 2300 mm, a surcharge is applicable. Mat deviations/splits possible at customer's request.
<b>Support chassis</b>	Reinforced support chassis made using rigid aluminium with sound absorbing insulation on the underside
<b>Support chassis colour</b>	Aluminium as standard. Anodised colours for an additional charge: EV3 gold, C33 mid-bronze, C35 black or C31 stainless steel
<b>Tread surface</b>	Recessed, robust, weather-proof, ribbed carpet strips.
<b>Slip resistance</b>	R 11 slip resistance as per DIN 51130
<b>Flammability</b>	Insert available on request (surcharge applicable) with fire classification Cfl-s1 according to EN 13501.
<b>Pile material</b>	100% PP (polypropylene)
<b>Colour fastness to artificial light ISO 105-B02</b>	good 6
<b>Colour fastness to rubbing ISO 105 X12</b>	good 4
<b>Colour fastness to water ISO 105 E01</b>	good 5

Accessories
emco installation frame 500: 500-25 AL Aluminium
emco installation frame 500: 500-25 CN Chrome-nickel steel (V2A)
emco LUMINA: LUMINA Aluminium
emco LUMINA: LUMINA + LED Aluminium
emco LUMINA: LUMINA VIA Aluminium
emco ramp edge: A17 Aluminium
emco T-profile: T22
emco cover strip: C22 Chrome-nickel steel (V2A)
emco INOX®: LINEO 22 Chrome-nickel steel (V2A)
emco INOX®: QUADRO 22 Chrome-nickel steel (V2A)
emco dirt collection well: 5000 AL Aluminium
emco dirt collection well: 5000 CN Chrome-nickel steel (V2A)
emco dirt collection well: 5000 AL+ Aluminium
emco dirt collection well: 5000 CN+ Chrome-nickel steel (V2A)
emco dirt collection well: 5022 AL Aluminium
emco dirt collection well: 5022 CN Chrome-nickel steel (V2A)
emco dirt collection well: 5022 AL+ Aluminium
emco dirt collection well: 5022 CN+ Chrome-nickel steel (V2A)
emco dirt collection well: 5522AL Aluminium
emco dirt collection well: 5522CN Chrome-nickel steel (V2A)
emco dirt collection well: 5022 AL Aluminium
emco dirt collection well: 5022 CN Chrome-nickel steel (V2A)
emco dirt collection well: 5522AL Aluminium
emco dirt collection well: 5522CN Chrome-nickel steel (V2A)
emco dirt collection well: 5000 AL+ Aluminium
emco dirt collection well: 5000 CN+ Chrome-nickel steel (V2A)
emco dirt collection well: 5022 AL+ Aluminium
emco dirt collection well: 5022 CN+ Chrome-nickel steel (V2A)
emco dirt collection well: 5000 AL Aluminium
emco dirt collection well: 5000 CN Chrome-nickel steel (V2A)
emco special frame with substructure: A Version A: with installation frame, rectangular tube profiles, grid support and height adjustment.
emco special frame with substructure: B Version B: with installation frame, grid support and rectangular tube profiles
emco special frame with substructure: C Type C: with installation frame and rectangular tube profiles
Rubber underlay 3 mm: GU 3
Rubber underlay 5 mm: GU 5
Rubber underlay 1 mm: GU 1

# emco MARSCHALL Original Large With ribbed carpet insert

## Model 522 SLR

### Accessories

Mat joining brackets: MV Supplied as standard with mats in several parts

### Suitable for:

Residential and care homes

Arena

medical practice

Train station

DIY store

Offices and administrative buildings

Family home

Shopping centre

Retail sector

University / Higher education institution

airport

Hotel

Industry

Kindergarten/Nursery

Clinic/Hospital

Warehouse

Apartment building

Trade fair

School

Sports hall

Supermarket

### Insert certified to TÜV PROFiCERT- product interior (Standard)

French VOC regulation

LEED v4 (outside North America)

BREEAM Exemplary Level

Belgian VOC regulation

AgBB (Committee for Health-related Evaluation of Building Products)

MVV TB Appendix 8, 9 / ABG

### Service and services

Construction site advice

Dimensioning

Measured using laser measuring device on site.

Installation service

Fitting and installation service

Repairs

The product can be disposed of or recycled in an environmentally friendly way.

## Model 522 SLR

### Colours

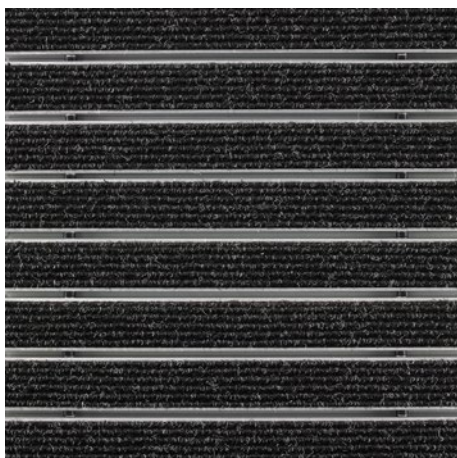

Anthracite no. 200

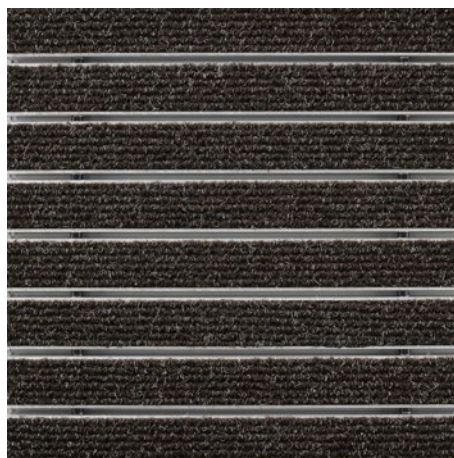

Brown no. 485

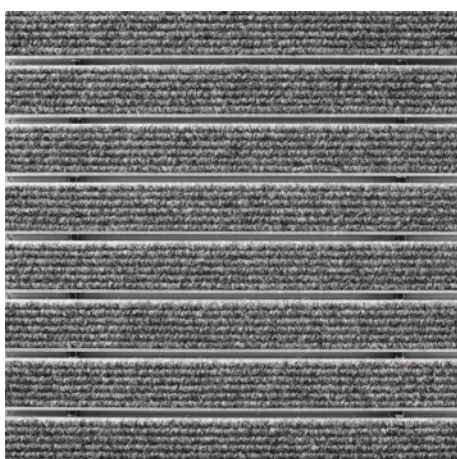

Light grey no. 220

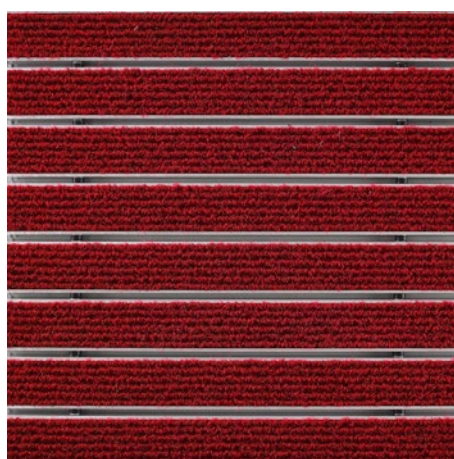

Red no. 305

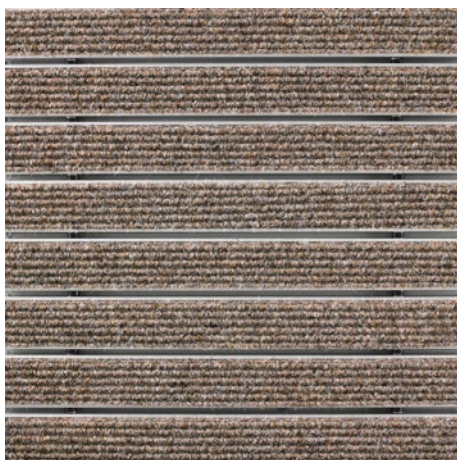

Sand no. 430

Warranty conditions are available at: [www.emco-bau.com/garantiebedingungen/](http://www.emco-bau.com/garantiebedingungen/)

Subject to technical modifications

emco Bautechnik GmbH · Breslauer Straße 34 - 38 · D-49808 Lingen (Ems)  
· Germany · Phone: +49 (0) 591/9140-500 · Fax: +49 (0) 591/9140-852 · Email:  
[bau@emco.de](mailto:bau@emco.de) · [www.emco-bau.com](http://www.emco-bau.com)

